

PRODUCTS FOR LAYING

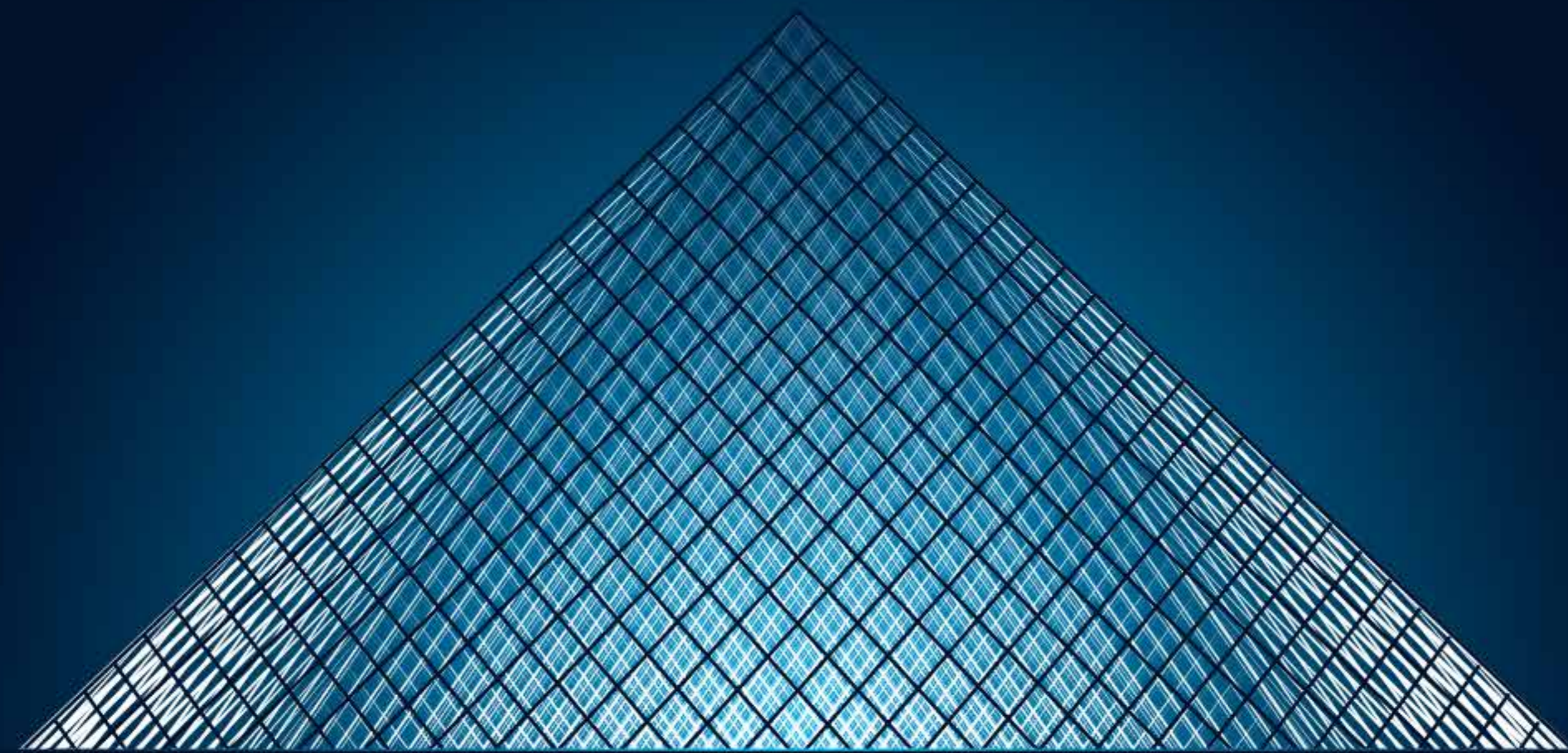

LOUVRE PYRAMID, PARIGI, 1989
I.M.Peï

TRANSPARENCY FOR A PERFECT LAYING.

PATENTED

Completely visible joint

H ≥ 50 mm

H ≥ 50 mm

The only one with 2 elements
Save 3 pieces on intersections

PATENTED

1407796
1424326
EP 2573296 B1
EP 2952652 B1
Patents Pending

Proleveling System

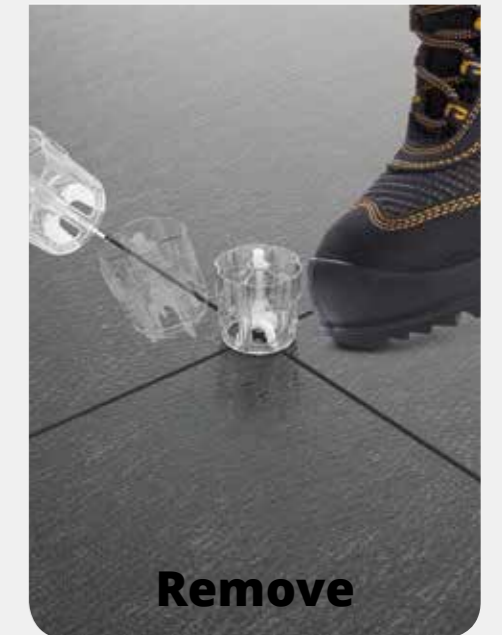

Kicking the clip in the direction of the joint.

ADVANTAGES

- 1 Simple and quick to lay with **only 2 elements: leveler & cap**. No need for expensive hand tools.
- 2 The only worldwide leveling system with multiple size levelers (2,3 and 5 mm). Built in spacers are available to accommodate "+" intersections as well as "T" joints **with a single leveler saving up to 3 pieces per joint**.
- 3 The only System capable of leveling 3 to 40 mm floors and wall coverings with only 2 parts: **leveler & cap**. Simply flip the cap over to work with various thicknesses.
- 4 It guarantees a minimum joint of 1 mm, maximum 5 mm.
- 5 Vertical compression reduces movement and widening of joints.
- 6 The thin base of the leveler allows for easy placement without mortar accumulation.
- 7 The shaped hole in the middle of the cross and T-shaped levelers allow a perfect control of the tiles lining up. Moreover the holes on their base enable a perfect anchoring between adhesive and tile.

© 2019 All rights reserved by Progress Profiles. Printed in Italy

© 2019 All rights reserved by Progress Profiles. Printed in Italy

DESCRIPTION

Proleveling System is a revolutionary and innovative leveling system when laying medium and large materials with a thickness between 3 and 40 mm. The patented system is made of 2 elements:

- A leveling base (1-2-3-5 mm size) with spaced notches that allow spacing/separating/ joining floors of any type and material in a way that is: linear, cross and half cross with joints to be chosen between 1mm, 2 mm, 3 mm and 5 mm.
- The threaded stem is attached perpendicularly to the base in a way that allows for easy adjustment with turns of the cap during installation. Removal of the cap and Stem after the materials are set is made easy with strategically placed breakage points that release with either increased pressure by turning the cap or by kicking the cap in the direction of the joint.

One cap fits all threaded stems and can be reused an infinite amount of times for big cost savings.

The new PPLS (patented) system assists in the reduction or elimination of ledging and lippage in the installation of various types of materials that are applied to floors or walls with mortar including: Large Format Tile, Natural Stone, Thin Profile Tile and many others.

LAYING SYSTEM

- Choose the desired type of Leveler (spacers) based on the requested joints and joining:
 - 1 mm Linear, Cross and Half Cross Version
 - 2 mm Linear, Cross and Half Cross Version
 - 3 mm Linear, Cross and Half Cross Version
 - 5 mm Linear, Cross and Half Cross Version
- Apply the thinset or mortar on a level base with the proper notched trowel as called out in the setting materials manufacturer's installation instructions.
- During the application of the tile or other materials, position the base of the chosen Leveler under the edge of the tile at the appropriate joint location and continue laying in sequence.
- Attach the cap to the threaded stem by rotating it clockwise. Level the joint by rotating the cap using the minimum amount of pressure needed.
- Once the setting materials have become solid and the floor or wall is ready for grout: kick the cap in the direction of the joint to detach connection points between base and stem.

Remover: Fixed on a drill allows to remove levelers from caps.



T-shaped leveler installation.



Linear leveler installation.

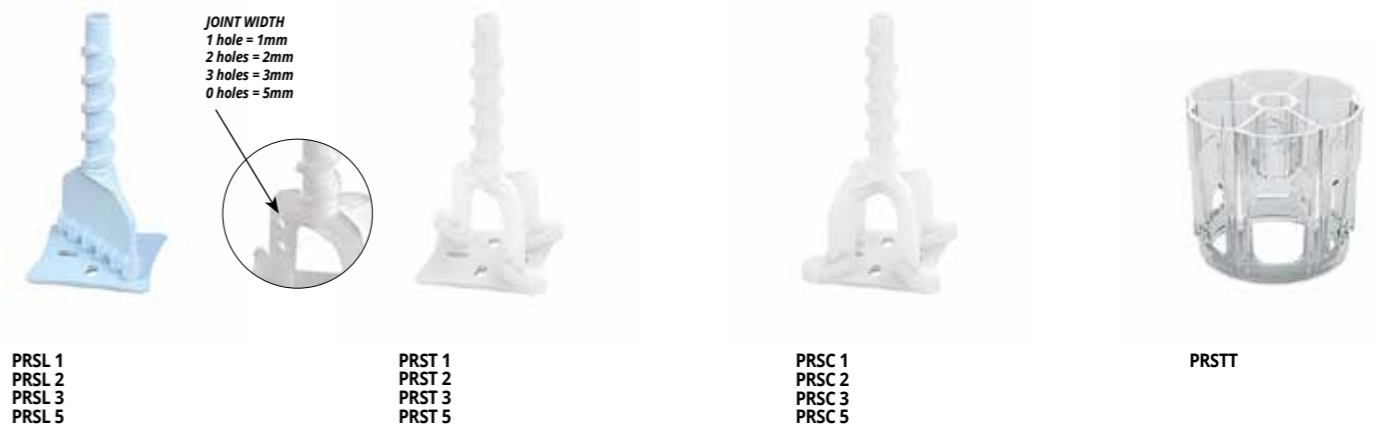

LINEAR LEVELER PROLEVELING SYSTEM

Article	thick mm	Pcs/ Pack.	€/Pc	€/Pack.	Box
PRSL 1	1	100	0,144	14,40	3000 Pcs
PRSL 2	2	100	0,144	14,40	3000 Pcs
PRSL 3	3	100	0,144	14,40	3000 Pcs
PRSL 5	5	100	0,144	14,40	3000 Pcs

"T" LEVELER PROLEVELING SYSTEM

Article	thick mm	Pcs/ Pack.	€/Pc	€/Pack.	Box
PRST 1	1	100	0,17	17,00	3000 Pcs
PRST 2	2	100	0,17	17,00	3000 Pcs
PRST 3	3	100	0,17	17,00	3000 Pcs
PRST 5	5	100	0,17	17,00	3000 Pcs

CROSS LEVELER PROLEVELING SYSTEM

Article	thick mm	Pcs/ Pack.	€/Pc	€/Pack.	Box
PRSC 1	1	100	0,17	17,00	3000 Pcs
PRSC 2	2	100	0,17	17,00	3000 Pcs
PRSC 3	3	100	0,17	17,00	3000 Pcs
PRSC 5	5	100	0,17	17,00	3000 Pcs

PROLEVELING SYSTEM REMOVER FOR LEVELER

Article	Pcs/ Pack.	€/Pc	€/Pack.	Box
PRSSV	50	0,82	41,00	1250 Pcs

ROTATING POMMEL CAP FOR LEVELER PROLEVELING SYSTEM

Article	Pcs/ Pack.	€/Pc	€/Pack.	Box
PRST	50	0,95	47,50	1000 Pcs

PROTECTION CAP FOR PROLEVELING SYSTEM

Article	Pcs/ Pack.	€/Pc	€/Pack.	Box
PRSPC	50	0,82	41,00	2500 Pcs

© 2019 All rights reserved by Progress Profiles. Printed in Italy

© 2019 All rights reserved by Progress Profiles. Printed in Italy

Tiles cm x cm	30 X 30	40 X 40	45 X 45	50 X 50	60 X 60	80 X 80	90 X 90	120 X 120
U. / MQ (Type of leveler)*	11 (only +)	6 (only +)	5 (only +)	4 (only +)	3 (only +)	5 (2+, 3L)	5 (2+, 3L)	3 (1+, 2L)

* + = cross leveler, L = linear leveler, T = "T" shape leveler

Tiles cm x cm	30 X 60	40 X 80	45 X 90	120 X 30	100 X 50	120 X 60
U. / MQ (Type of leveler)*	6 (only +)	6 (3+, 3L)	6 (3+, 3L)	6 (3+, 3L)	4 (2+, 2L)	4 (2+, 2L)

* + = cross leveler, L = linear leveler, T = "T" shape leveler

Tile cm x cm	10 X 100	12 X 100	15 X 100	20 X 100	10 X 120	12 X 120	15 X 120	20 X 120	10 X 80	12 X 80	15 X 80	20 X 80	40 x 80	45 x 90	100 x 50	120 x 60
U. / MQ (Type of leveler)*	20 (only T)	17 (only T)	14 (only T)	10 (only T)	17 (only T)	14 (only T)	11 (only T)	9 (only T)	25 (only T)	21 (only T)	17 (only T)	13 (only T)	6 (only T)	5 (only T)	4 (only T)	4 (only T)

* + = cross leveler, L = linear leveler, T = "T" shape leveler

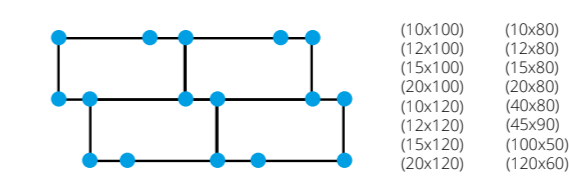

PROSUPPORT TUBE SYSTEM

BASE + SCREW + EXTENSION + MULTI-FUNCTION HEAD SELF-LEVELLING AND FIX

PROSUPPORT TUBE SYSTEM is an adjustable and modular supports system for outdoor floating floors from the height of 29 mm to 1000 mm. The system is composed of 1 base, 2 screws, 1 flange, 2 heads and several pvc pipes to obtain the requested height. Both heads, according to the screw, can be fix or self-levelling.



KIT DIFFERENT HEIGHTS (base + screws without head)
polypropylene - pack 40 kit (box 40 pcs)

Article	H (mm)	H (mm) Fix	€/Pc	€/Pack.
PSTK 0202	34 / 54	29 / 49	X,XX	XX,XX
PSTK 0204	54 / 74	49 / 69	X,XX	XX,XX

Items not for sale individually. Minimum order one pack.



Head with removable flaps 2/4 mm
polypropylene - pack 40 pcs

Article	Flap thickness (mm)	€/Pc	€/Pack.
PSTH 02	2	X,XX	XX,XX
PSTH 04	4	X,XX	XX,XX

Items not for sale individually. Minimum order one pack.



ANTI-NOISE AND ANTI-SLIP DISK
rubber - H 1,5 mm - Ø 150 - pack 40 pcs

Article	H / Ø mm	€/Pc	€/Pack.
PSTG	H 1,5 - Ø 150	X,XX	XX,XX

The non-slip rubber disk to be used with the heads of PROSUPPORT TUBE SYSTEM reduces noises till 25 dB.
Items not for sale individually. Minimum order one pack.

TABLE OF PEDESTALS HEIGHTS with items in the catalogue

Base kit + screws	Head	Flange	Pipe	Type A* (H mm) min/max	Type B* (H mm) min/max
PSTK 02	PSTH 04 / 02			34/54	29/49
PSTK 04	PSTH 04 / 02			54/74	49/69
PSTK 02	PSTH 04 / 02	PSTGH 02	PSTT35	74/94	67/87
PSTK 02	PSTH 04 / 02	PSTGH 02	PSTT55	94/114	87/107
PSTK 02	PSTH 04 / 02	PSTGH 02	PSTT75	114/134	107/127
PSTK 02	PSTH 04 / 02	PSTGH 02	PSTT95	134/154	127/147
PSTK 02	PSTH 04 / 02	PSTGH 02	PSTT115	154/174	147/167
PSTK 02	PSTH 04 / 02	PSTGH 02	PSTT135	174/194	167/187
PSTK 02	PSTH 04 / 02	PSTGH 02	PSTT155	194/214	187/207

* Type A self-levelling head / Type B fixed head



OUTER DIAMETER PIPE 110 mm THICKNESS 4 mm
pvc or polyethylene

Article	H (mm)	Pcs/pack	€/Pc	€/Pack.
PSTT 35	35	40	X,XX	XX,XX
PSTT 55	55	40	X,XX	XX,XX
PSTT 75	75	40	X,XX	XX,XX
PSTT 95	95	40	X,XX	XX,XX
PSTT 115	115	40	X,XX	XX,XX
PSTT 135	135	40	X,XX	XX,XX
PSTT 155	155	40	X,XX	XX,XX

Items not for sale individually. Minimum order one pack.



CONNECTION NUT 40 mm
polypropylene - pack 40 pcs

Article	H (mm)	€/Pc	€/Pack.
PSTGH 02	40	XX,XX	XXX,00

Connection nut with a lower side of 110 mm inner diameter, where the pipe of different heights should be inserted, and one side with thread where the regulation screws should be inserted.
Items not for sale individually. Minimum order one pack.

UPON REQUEST IT IS POSSIBLE TO HAVE HEIGHTS TILL 1000 MM USING PIPES FROM 155 TILL 955.
For information and installation instructions ask for the technical data sheet. Delivery time and prices to be agreed.

HOW TO ORDER:

Heights from 29 to 74 mm
1) Choose the kit code no. (base+screws without head) of the needed height (Ex. PSTK 0202).
2) Choose the code no. of the needed head (Ex. PSTH 04).

For heights from 74 till 155 mm
1) Choose the code of the kit without head of the requested height. (Ex. PSTK 0202).
2) Choose the code of the requested head. (Ex. PSTH 04).
3) Choose the pipe of the requested height (Ex. PSTT 55).
4) Choose the connection nut PSTG 02.



TYPE A
Self-levelling head
Max height 1000 mm
with max slope of 5%.



Type B
Fixed head
Max height 1000 mm



PROSUPPORT TUBE SYSTEM OPTIONAL

ADJUSTING KEY (only for head PSTHG 04)

Article	€/Pc
PSTAK	X,XX



ADJUSTABLE SPACER TABS 4 mm
polypropylene - Pack 80 pcs

Article	L x H (mm)	€/Pc	€/Pack.
PSTJ	80 x 20	X,XX	XX,XX

Spacer tabs 80 mm long to be fixed on the self-levelling head, which allow the fixing of wooden, WPC and aluminium joists of max width 80 mm.



Items not for sale individually. Minimum order one pack.

FIXING CLIP FOR TILES
Pack 40 pcs

Article	L x H mm	€/Pc	€/Pack.
PSTWP	20 x 60	X,XX	XX,XX

Fastening clip to fix the tiles and block the floor in case of strong wind. The clips must be inserted inside the cross joint or along the perimeter of the floor.



Items not for sale individually. Minimum order one pack.

© 2019 All rights reserved by Progress Profiles. Printed in Italy

© 2019 All rights reserved by Progress Profiles. Printed in Italy



PRODUCTS FOR LAYING

PROSUPPORT SYSTEM

BASE + SCREW + EXTENSION + SELF - LEVELLING OR FIXED HEAD

PROSUPPORT SYSTEM is a pedestal support system for outdoor raised floors. **PROSUPPORT SYSTEM** height is fully adjustable from a minimum of 35 mm to a maximum of 500 mm. **PROSUPPORT SYSTEM** is a modular fully adjustable system made of Polypropylene suitable for outdoor areas like roof tops, terrace, pool surroundings, pedestrian walkways, decks and patios. Available in the self-leveling head version and flat head version.

FIXED HEAD PACK KIT (without head)

polypropylene - box 40 pcs
(base + screw: PSRG3555, PSRG5570, PSRG70110, PSRG11150)
(base + screw + extension + screw: PSRG15170, PSRG17200)

Article	H (mm)	Pack / pallet	€/Pc	€/Pack.
PSRG3555	35/55	40	3,61	144,40
PSRG5570	55/70	40	3,86	154,40
PSRG70110	70/110	40	4,53	181,20
PSRG11150	110/150	40	5,15	206,00
PSRG15170	150/170	40	7,78	311,20
PSRG17200	170/200	40	8,29	331,60

Items not for sale individually. Minimum order one pack. One pack is composed of 40 complete kit.

HOW TO ORDER

1) Choose the code of the KIT without the head in the desired height (Ex: PSRG5570) 2) Choose the code of the desired head (Ex: PSRG 04)

EXAMPLE - To order 80 pieces

of Prosupport with self-leveling head with 4 mm thick flaps and variable height from 70 to 110 mm

WRITE IN THE ORDER:

2 packs of 40 pcs code PSRG70110
+ 2 packs of 40 pcs code PSRG 04

PROSUPPORT SYSTEM HEIGHTS (Higher heights up to 500 mm on demand, price and delivery time to be agreed)

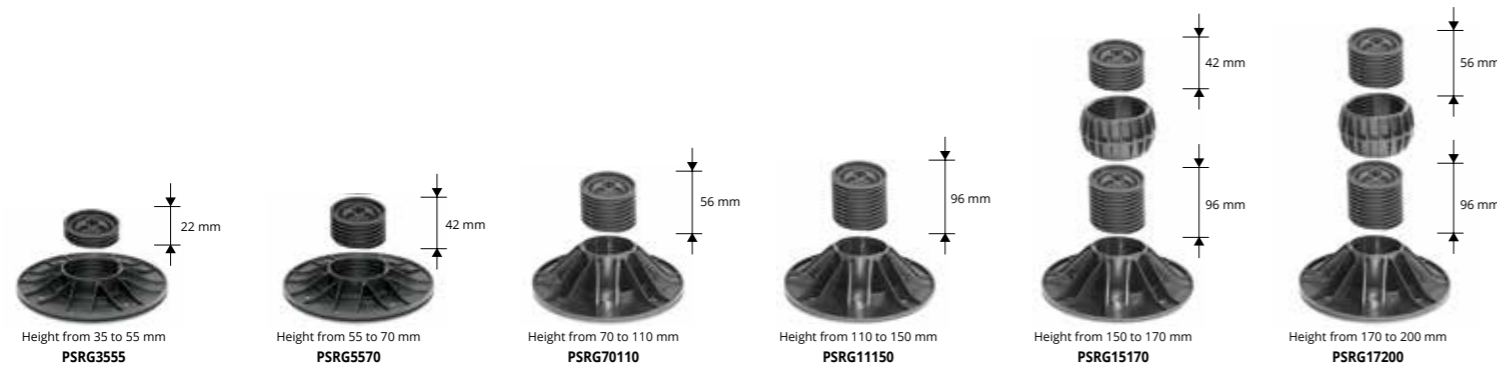

SELF - LEVELLING HEAD with removable flaps 2/4 mm

polypropylene - pack 40 Pcs (box 40 pcs)

Article	Flap thick. (mm)	Pack / pallet	€/Pc	€/Pack.
PSRG 02	2	90	0,98	39,20
PSRG 04	4	90	0,98	39,20

Items not for sale individually. Minimum order one pack. One pack is composed of 40 pcs.

SELF - LEVELLING HEAD

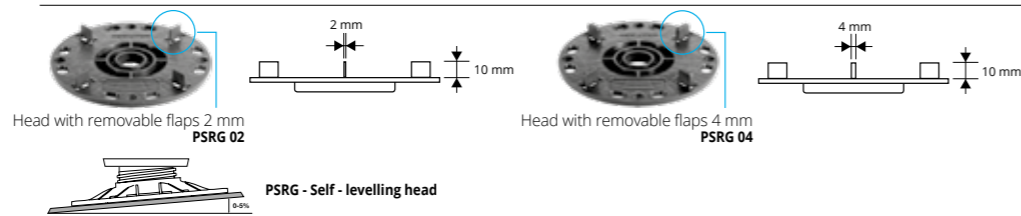

FIXED HEAD with removable flaps 2/4 mm

polypropylene - pack 40 Pcs (box 40 pcs)

Article	Flap thick. (mm)	Pack / pallet	€/Pc	€/Pack.
PSTP 02	2	90	0,52	20,80
PSTP 04	4	90	0,52	20,80

Items not for sale individually. Minimum order one pack. One pack is composed of 40 pcs.

FIXED HEAD

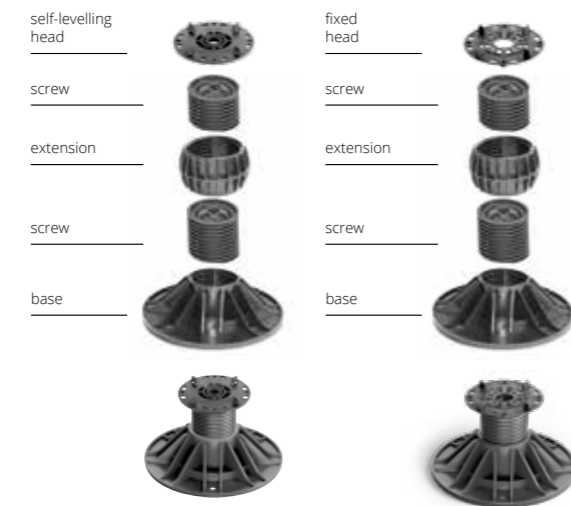
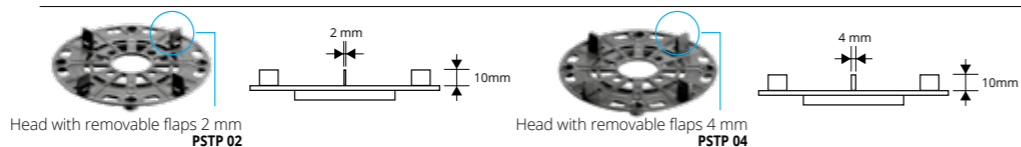

FIXED HEAD PACK KIT

(with head PSRG 04)
polypropylene - box 50 pcs
(5 pack with 10 pcs)

Article	H (mm)	€/Pc	€/Pack.
PSRG3555/50	35/55	5,05	252,50
PSRG5570/50	55/70	5,36	268,00
PSRG70110/50	70/110	6,08	304,00
PSRG11150/50	110/150	6,75	337,50

PROSUPPORT SYSTEM OPTIONAL

ADJUSTABLE SPACER TABS 4MM - polypropylene

length 60 mm - Pack. 80 Pcs (box 80 pcs)

Article	L x H (mm)	€/Pc	€/Pack.
ALDPS 60	60 x 20	0,72	57,60

Spacer tabs, 60 mm length, to be fixed on the self-leveling head. They allow the application of wooden, WPC and Aluminium joists with a maximum width of 80 mm, for the laying of wooden and WPC flooring.



RUBBER DISK for laying on bituminous roof membrane

H 2 mm - Pack. 100 Pcs (box 100 pcs)

Article	H (mm)	€/Pc	€/Pack.
LVGG 02	2	1,55	155,00

Rubber disc, 2 mm thick, to be applied under the support (SQG 15) to protect the bituminous membrane.



ANTI-NOISE AND ANTI-SLIP RUBBER DISK

H 3 mm - Ø 110 - Pack. 180 Pcs (box 180 pcs)

Article	H (mm)/Ø	€/Pc	€/Pack.
GARPS 3110	H 3 - Ø 110	1,24	223,20

Rubber disk designed to reduce noise up to 25 db and prevents slipping of the tiles. Height 3 mm and diameter 110 mm. To be placed on the self-leveling or fixed head.



SPACER FOR APPLICATION ON GRAVEL

Pack. 100 Pcs (box 100 pcs)

Article	€/Pc	€/Pack.
DILV	0,72	72,00

Transparent plastic cross spacer for laying on gravel or irregular surfaces.



FLANGE LOCKING DEVICE - POLYPROPYLENE

H 8 mm - Ø 75 - Pack. 250 Pcs (box 250 pcs)

Article	H (mm)/Ø	€/Pc	€/Pack.
AFBPS 875	H 8 - Ø 75	1,24	310,00

Locking Flange prevents the rotation of the screw to avoid flooring movements over time. Height 8 mm and diameter 75 mm. To be placed at the bottom of the screw.



ADJUSTING KEY (only for PSRG 04 and PSTP 04)

Article	€/Pc	€/Pack.
PSAK	12,88	



PROSUPPORT ECO is an adjustable support system for the realization of outdoor floating floors from a minimum height of 35 mm to a maximum of 110 mm. The flat head is adjustable in height and is equipped with removable spacers. The extensions have a height of 25 and 50 mm. The system, made in polypropylene (PP), is suitable for outdoor areas, terraces, pool pavements and pedestrian walkways.

PROSUPPORT ECO

POLYPROPYLENE



HOW TO ORDER

1) Choose the code of the desired BASE KIT with head (Es.: PSEC 3045)
2) Choose the code of the desired extra extension (Es.: PRSEC 50)

EXAMPLE

To order 60 pieces of Prosupport ECO with head 4 mm thick flaps and variable height from 85 to 110 mm

WRITE IN THE ORDER:

2 Packs of 30 pcs code PSEC 3045
+ 2 Packs of 30 pcs code PRSEC 50

HIGHER HEIGHTS ON DEMAND (UP TO A MAXIMUM OF 500 MM), PRICE AND DELIVERY TIME TO BE AGREED.

BASE KIT WITH HEAD and removable flaps 2 / 4 mm

polypropylene - pack. 30 Pcs (box 30 kit)

Article	Flap thickness (mm)	Pack / pallet	€/Pc	€/Pack.
PSEC 30452	2	40	3,71	111,30
PSEC 3045	4	40	3,71	111,30

Items not for sale individually. Minimum order one pack. One pack is composed of 30 complete kit.

BASE KIT



EXAMPLES BASE KIT + EXTENSION



EXTRA EXTENSIONS PROSUPPORT ECO

polypropylene - pack. 30 Pcs (box 30 pcs)

Article	H (mm)	Pack / pallet	€/Pc	€/Pack.
PRSEC 25	25	90	0,31	9,30
PRSEC 50	50	54	0,82	24,60

Items not for sale individually. Minimum order one pack. One pack is composed of 30 pcs.

EXTRA EXTENSION



SUPPORT and **LEVELLER** are suitable for the realization of outdoor floating floors. The support, in polyethylene, has a height of 15 mm. The rubber leveller, with a thickness of 3 mm, can be applied on the supports up to a maximum of 2. **SUPPORT** and **LEVELLER** are suitable for outdoor areas, terraces, pool edges and pedestrian crossings.

SUPPORT AND LEVELLER

POLYETHYLENE

SQUARES SUPPORT

boxes of 350 Pcs

Article	Thick. mm	€/Pc	€/Pack.
SQG 15	15	0,28	98,00

Items not for sale individually.



SUPPORT

SQUARES LEVELLER

boxes of 100 Pcs

Article	Thick. mm	€/Pc	€/Pack.
LQG 03	3	0,22	22,00

Items not for sale individually.



LEVELLER

SQG 15

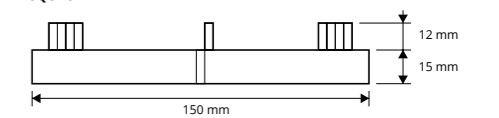

LQG 03

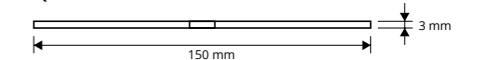

LAYING INSTRUCTIONS

1. Lay the supports on the waterproofing membrane. 2. To reach the desired height or compensate different heights, if necessary, place 1 or 2 rubber levelers on the support. 3. Lay the floating flooring.

PERIMETER SPACER PROSUPPORT SYSTEM

PERIMETER SPACER PROSUPPORT SYSTEM

Stainless steel AISI 316L / 1.4404 - V4A - pack. 50 Pcs

Article	€/Pc	€/Pack.
DPP	2,80	140,00

Perimeter spacer of stainless steel AISI 316L / 1.4404 - V4A for laying outdoor floating floors. The profile makes a 5 mm wide perimeter gap, for the outflow of rainwater; moreover, thanks to the rounded flin with which is provided, it does not damage the waterproofing sheath. The slit width of 0.5 cm and the length of 18 cm ensure a perfect anchorage of the spacer with the heads of the Prosupport System.

DPP

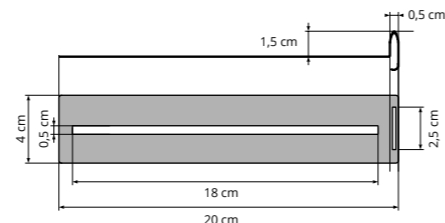
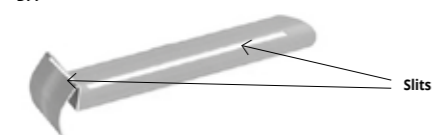

PROSUPPORT PROFILE T & N

VARNISHED ALUMINIUM
NATURAL ALUMINIUM

PROSUPPORT PROFILE T & N is a profile for the protection and finishing of the external edge of raised floors in ceramic, wood and composite materials. The vertical section of the profiles features a specially designed fins that create a dovetail cladding system. This dovetail cladding system allows for the adhesive used to fix the covering to also mechanically bond to the profiles. The profile is also available with a decorative edge of 2 cm height (PROSUPPORT PROFILE T).

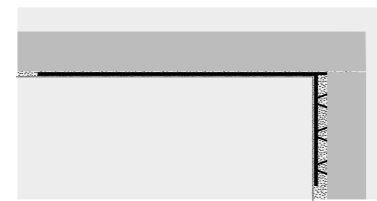
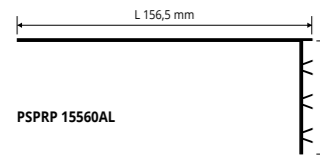
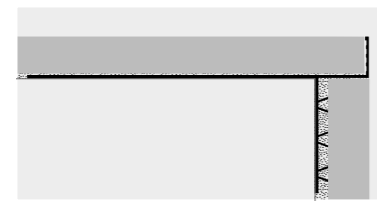
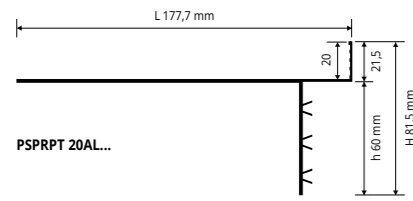

LAYING INSTRUCTIONS

1. Choose "PROSUPPORT PROFILE" desired model. 2. Cut "PROSUPPORT PROFILE" to the desired length and put on the supports and aligning. 3. Lay the floor by adjusting the height of the supports until completely leveling. 4. Cut the tiles of the correct size to close the perimeters of the floating floor. 5. Fix on the vertical surface of the profile the tiles using a suitable adhesive.

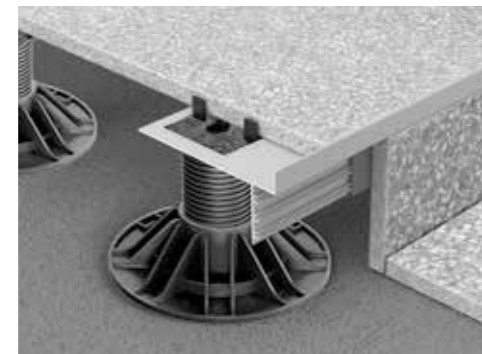

PROSUPPORT PROFILE T - VARNISHED ALUMINIUM
bar length 2,7 lm - pack. 20 Pcs - 54 lm

Article	L x H mm	h mm	€/lm	€/Pc
PSPRPT 20AL...	177,7x81,5	60	24,72	66,74

COLOURS (EMBOSSSED)

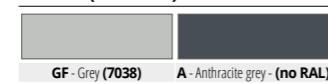

ON DEMAND (EMBOSSSED)

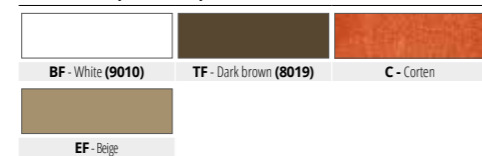

PROSUPPORT PROFILE N - NATURAL ALUMINIUM
bar length 2,7 lm - pack. 20 Pcs - 54 lm

Article	H mm	L	€/lm	€/Pc
PSPRP 15560AL	60	156,5	16,48	44,50

COLOURS



PROSUPPORT PROFILE A & B

VARNISHED ALUMINIUM, NATURAL ALUMINIUM

PROSUPPORT SYSTEM A&B Perimeter profile to protect and finish the outer edge of raised floors of different types, ceramic, wood, stone etc. The **PROSUPPORT PROFILE A** consists in an "L"-shaped horizontal flat base to insert and anchor above the **PROSUPPORT** Self-levelling head and a vertical visible part to insert in the vertical "L"-shaped element (as indicated in the drawing).

Use: Perimeter profile to protect and finish the outer edge of raised floors of different types, ceramic, wood, marble etc. The **PROSUPPORT PROFILE** consists in an "L"-shaped horizontal flat base to insert and anchor above the **PROSUPPORT** Self-levelling head and a vertical visible part to insert in the vertical "L"-shaped element (as indicated in the drawing).

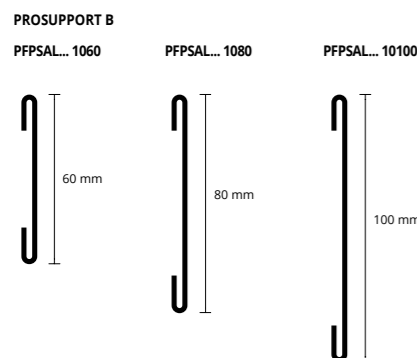

PUNCHED AND PERFORATED PROSUPPORT A
NATURAL ALUMINIUM - length 2,7 lm - pack. 20 Pcs

Article	L x H	€/lm	€/Pc
BPPSAN 15015	150 X 15	21,58	58,27
BPPSAN 15020	150 X 20	22,61	61,05
BPPSAN 15025	150 X 25	23,64	63,83

COLOURS

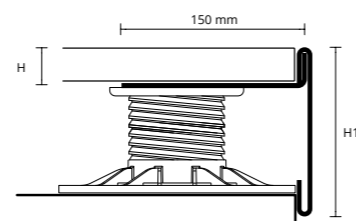

TOP PROFILE PROSUPPORT B - VARNISHED ALUMINIUM
length 2,7 lm

Article	H1	€/lm	€/Pc
PFPBSAL... 1060 (Pack. 20 Pcs)	60	15,97	43,12
PFPBSAL... 1080 (Pack. 10 Pcs)	80	18,54	50,06
PFPBSAL... 10100 (Pack. 10 Pcs)	100	20,86	56,32

COLOURS (EMBOSSSED)

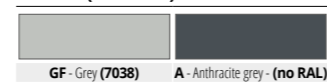

ON DEMAND (EMBOSSSED)

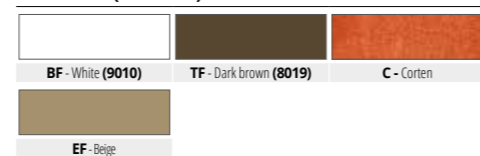

MULTISPACER Removable and reusable spacer for joints of tiled floors and walls. Its little tabs and open shape allows various uses with a perfect joint and view of the junctions among tiles during the laying.

MULTISPACER

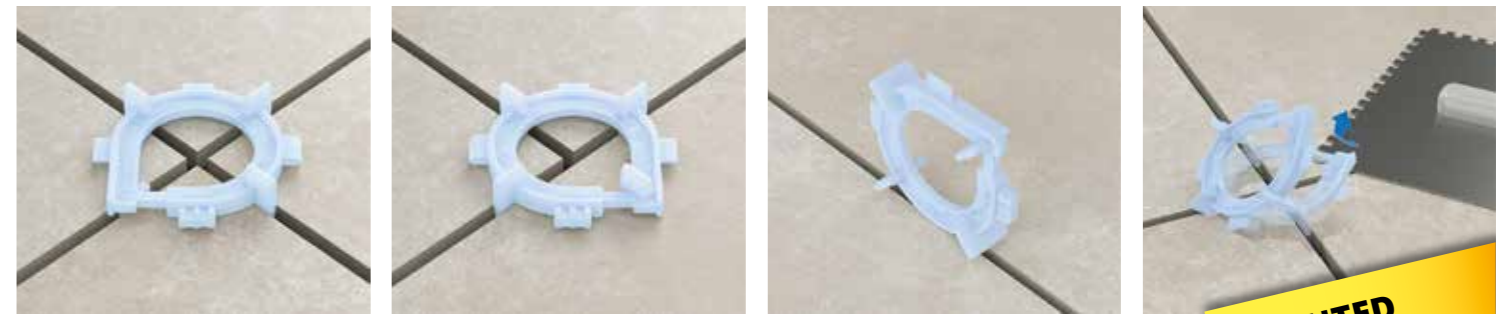

PATENTED

Article	Thick. mm	Pcs/pack	Pcs/Box	€/Pc	€/Pack.
MSP 1	1	100	3000	0,170	17,00
MSP 2	2	100	3000	0,175	17,50
MSP 3	3	100	3000	0,180	18,00
MSP 5	5	100	3000	0,195	19,50

Leveling system for tiles composed of 3 elements: wedge, leveler and plier. The levelers are available for grout lines of 1/1.5/2 and 3 mm and are suitable for tiles with thickness from 3 to 12 mm. The wedge, with a length of 90 mm and a width of 22 mm, is inserted during the laying inside the leveler and thanks to the plier we get a complete flatness between adjacent tiles. When the adhesive is hardened, kick the wedges and the protruding part of the levelers along the grout line.

PROLEVELING WEDGE SYSTEM

PROLEVELING WEDGE SYSTEM

Article	Description	Thick. mm	Pcs/pack	Pcs/Box	€/Pc	€/Pack.
PRLW	Leveling wedge	-	100	2000	0,160	16,00
PRLW 1	Linear leveler thick 1 mm	1	200	4000	0,140	28,00
PRLW 15	Linear leveler thick 1,5 mm	1,5	200	4000	0,145	29,00
PRLW 2	Linear leveler thick 2 mm	2	200	4000	0,150	30,00
PRLW 3	Linear leveler thick 3 mm	3	200	4000	0,155	31,00



TRACTION PLIER for PROLEVELING WEDGE SYSTEM

Article	Pcs/pack	€/Pc
PRLWP	1	22,90



The **CROSS-SHAPED** and **T-SHAPED SPACERS** are perforated, weatherproof and made in top quality material with choice of colour. They are used to provide regular gaps in floors and coverings and thanks to the anti-floating perforations remain in the correct laying position. Available in every required thickness 1 - 2 - 3 - 4 - 5 - 7 - 10 mm. Levelling wedges are also available for compensating differences in level that emerge during laying. The **Y-SHAPED SPACERS** have to be used to separate hexagonal tiles in floors and walls. Available in thickness 2 and 3 mm.

SPACERS LEVELLING WEDGES

PERFORATED SPACERS CROSS-SHAPED

boxes with bags of 250 Pcs each

Article	Thick. mm	Pcs/Box	€/Bag	€/Pc
RC 1	1	20.000	2,18	0,0087
RC 2	2	15.000	2,18	0,0087
RC 3	3	15.000	2,18	0,0087
RC 4	4	15.000	2,18	0,0087
RC 5	5	15.000	2,18	0,0087
RC 7	7	10.000	2,38	0,0095
RC 10	10	5.000	4,50	0,0180

PERFORATED SPACERS T-SHAPED

boxes with bags of 250 Pcs each

Article	Thick. mm	Pcs/Box	€/Bag	€/Pc
RT 1	1	20.000	2,18	0,0087
RT 2	2	15.000	2,18	0,0087
RT 3	3	15.000	2,18	0,0087
RT 4	4	15.000	2,18	0,0087
RT 5	5	15.000	2,18	0,0087
RT 7	7	10.000	2,38	0,0095
RT 10	10	5.000	4,50	0,0180



SPACERS / SQ.M

TILE FORMAT cm x cm	60 x 60	60 x 30	40 x 40	40 x 30	40 x 20	33 x 33	30 x 30	30 x 20	25 x 25	20 x 20	15 x 15	13 x 26	13 x 13	10 x 20	10 x 10
CROSS-SHAPED SPACERS No. / Sq.m	3	6	7	9	12	9	11	17	16	25	44	30	60	50	100
T-SHAPED SPACERS No. / Sq.m	6	12	14	18	24	18	22	34	32	50	88	60	120	100	200

Y-SHAPED SPACERS 2 spacers for each tile multiplied by the amount of tiles per square meter

Y-SHAPED SPACERS FOR HEXAGONAL TILES

boxes with bags of 250 Pcs each

Article	Thick. mm	Pcs/Box	€/Bag	€/Pc
RY 2	2	10.000	1,85	0,0074
RY 3	3	10.000	1,85	0,0074

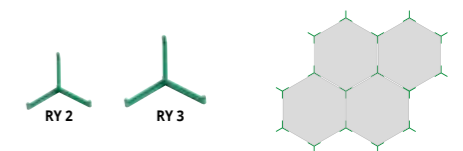

LEVELLING WEDGES

boxes with bags of 500 Pcs

Article	Thick mm	Pcs/Box	€/Bag	€/Pc
PCU 5	0 - 5	10.000	4,35	0,0087

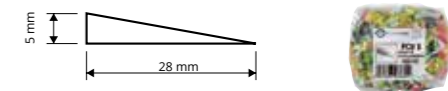

© 2019 All rights reserved by Progress Profiles. Printed in Italy

© 2019 All rights reserved by Progress Profiles. Printed in Italy

PRODUCTS FOR LAYING

MAGNET KIT

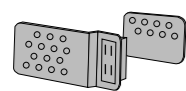

MAGNET KIT - 4 magnets and 4 plates
for ceramic inspection panel - packs of 10 kits - price for 1 Kit

Article	€/KIT
KMD	10,48

SCISSORS FOR PVC PROFILES



SCISSORS
for cutting PVC profiles

Article	€/Pc
FTPP	72,78

PROECOFON

EXPANDED POLYETHYLENE CLOSED - CELL

PROECOFON is a roll of closed-cell polyethylene used as edging between the wall and screed or where there are expansion joints. It should be used in all floor-laying work to ensure long life of the floor.



CLOSED-CELL EXPANDED POLYETHYLENE

Article	Thick. x H mm	lm/roll	€/lm	€/Roll
PEF 550A	5 X 50	25	1,63	40,75
PEFPU 510A	5 X 10	2,7	2,22	5,99
PEF 5100A	5 X 100	100	0,65	65,00

For perimeter areas and joints.
PEFPU 510A for Proterrace Drain Drip

EXEMPLES OF LAYING

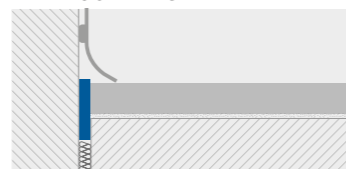

PROBAND FIX

MONOCOMPONENT WATERPROOF SEALANT



SEALANT MONOCOMPONENT WATERPROOF

Pack of 12 cartridges

Article	Colours	Cartridge lm	€/Pc	€/Pack.
PRBFXB	White	290	13,91	166,92
PRBFXG	Grey	290	13,91	166,92

DISPENSING GUN FOR SEALANT CARTRIDGES

Article	Pc/Pack	€/Pc
PRBFXGUN	1	278,10

SEALANT MONOCOMPONENT WATERPROOF CARTRIDGE

Pack of 12 cartridges

Article	Colours	Cartridge lm	€/Pc	€/Pack.
PRBFXUB	White	600	27,30	327,60
PRBFXUG	Grey	600	27,30	327,60

COLOURS

B - White	G - Grey
-----------	----------

Technical data:

Appearance: white or gray thixotropic paste
Temperature range for application: + 5 °C / + 40 °C
Temperature range: - 40 °C / + 90 °C
Curing: ≈ 2 mm / 24 h
Commissioning: ≈ 7 days

Suggestions for the installation:

In general cementitious support must be free from dust, oil and grease, dry and free from any visible moisture, free of loose or imperfectly anchored parts such as residual traces of cement, lime and paint, which must be totally removed. In case of contact with eyes, rinse immediately with water and seek medical advice. Avoid contact with skin and keep out of reach of children.

• Use
Balconies, terraces, bathrooms, kitchens, saunas, swimming pools and exterior surfaces of any size.

• Don't use
On bitumen membranes.
To seal proband with PRODESIO®.

PROSKIRTING FIX

NEUTRAL ONE-COMPONENT LOW MODULE SILICONE

Neutral, one-component, low module silicone, odorless, suitable to fix the skirting in stainless steel, aluminum, foamed vinyl resin and rigid vinyl resin on absorbent and non-absorbent supports



Article	Cartridge lm	Pcs/Pack	€/Pc	€/Pack.
PRSFXT	310	12	12,62	151,44

PROPOLISH

WHITE CREAM - BASED SURFACTANTS SUITABLE FOR CLEANING

White cream - based surfactants, amines and inert powder, suitable for cleaning, degreasing and polishing of stainless steel surfaces and opaque/matt brass. The product, ready to use, does not contain acids and alkalis and do not leave marks after use. It does not emit harmful substances



Article	Pack. g.	Pcs/Pack	€/Pc	€/Pack.
PRLISH	250	6	15,97	95,82



Article	Pack. lm	Pcs/Pack.	€/Pc	€/Pack.
PRCLEAN	750	6	15,45	92,70

PROCARE CLEAN

CLEANING SPRAY

Cleaning spray ready to use suitable for cleaning of stainless steel, brass and aluminum profiles, from residual surface oxide and limestone. The product deposit a protective film that prevents the deposit of limestone and soap residues. Its periodic use allows to obtain bright and cleaner surfaces for long period. Suitable also for glasses, mirrors and bathroom fittings.

TROWEL in steel foil 3x3, support in polished aluminium with electro welded fixing. Rubber grip fixed with an anti-rotation system. Particularly suitable for the laying of the waterproofing system PROFOIL.

TROWEL

STAINLESS STEEL

TROWEL STAINLESS STEEL

Box 6 Pcs

Article	Tooth	Dimensions mm	Pcs/Box	€/Pack.	€/Pc
PFTT33	3X3	280X120	6	80,34	13,39

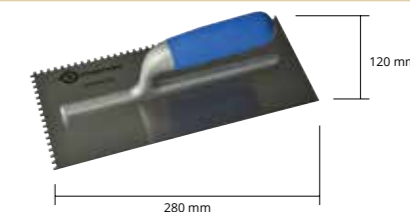

TROWEL in steel foil 5x7, support in polished aluminium with electro welded fixing. Rubber grip fixed with an anti-rotation system. Particularly suitable for the laying of the waterproofing and uncoupling systems PRODESIO® and PRODESIO® HEAT & PRODESIO® HEAT GRIP.

TROWEL

STAINLESS STEEL

TROWEL STAINLESS STEEL

Box 6 Pcs

Article	Tooth	Dimensions mm	Pcs/Box	€/Pack.	€/Pc
PFTT57	5X7	280X121	6	80,34	13,39

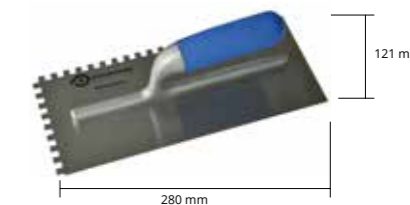

TROWEL in steel foil 10x10, support in polished aluminium with electro welded fixing. Rubber grip fixed with an anti-rotation system. Particularly suitable for the laying of tiles above the waterproofing and uncoupling systems PRODESIO® and PRODESIO® HEAT & PRODESIO® HEAT GRIP.

TROWEL

STAINLESS STEEL

TROWEL STAINLESS STEEL

Box 6 Pcs

Article	Tooth	Dimensions mm	Pcs/Box	€/Pack.	€/Pc
PFTT1010	10X10	280X122	6	80,34	13,39

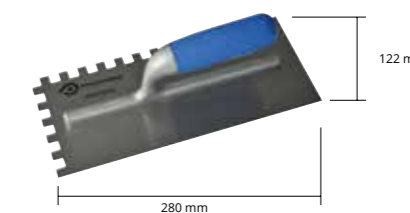

TROWEL in PVC size 10x10 cm, resistant to solvents, with a triangular teeth of interaxle spacing of 5 mm, 4 mm and 3 mm. To be used for the application of adhesives PROBAND FIX and PROSKIRTING FIX.

TROWEL

PVC

TROWEL

Article	Dimensions mm	€/Pc
PRSPD 10	100x100	2,99

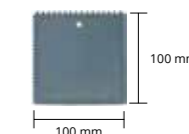

ROLLER in nylon, 40 cm long, fixed to a varnished metal or stainless steel 304 frame, suitable for pressing the PRODESIO®, PRODESIO® HEAT & PRODESIO® HEAT GRIP and PROFOIL. The roller is equipped with an extendable grip, length-adjustable and with an L base that allows to load 1 bag of adhesive to obtain the correct and homogenous pressing of the membranes. A tripod allows to keep the roll in the right position while loading the bag.

ROLLER

VARNISHED STEEL OR STAINLESS STEEL

ROLLER IN STAINLESS STEEL

L 40 cm

Article	L mm	Finish	€/Pc
PSM	400	varnished	406,85
PSMAC	400	stainless steel	515,00

