

KAUFMANN HOUSE, "FALLINGWATER", 1939
Frank L. Wright

PROSHOWER SYSTEM LINEAR KIT

PROSHOWER SYSTEM LINEAR KIT is an innovative solution, which combines functionality and design to answer to all requirements of the shower.



Article	Description	Pc/Pack.	€/Pc
PSHPANEK	PROSHOWER SYSTEM LINEAR KIT BASE	1	355,00

Article	Kit components	Pc/Pack.
PSHPAN...	Proshower panel in moulded polystyrene 120x120 cm with glued Profoil	1
PRBFXB	PROBAND FIX white	2
PRBPE 1507	ROLL PROBAND 150 - 7,5 lm	1
PFLO 0405	PROFOIL ROLL - 5 lm	1
PIAA 40212	ALUMINIUM PROFILES (screed leveling profile) length 120 cm	2
PRSPD	PVC TOWEL	1



PROSHOWER PANEL EXTENSION EXEMPLES OF LAYING

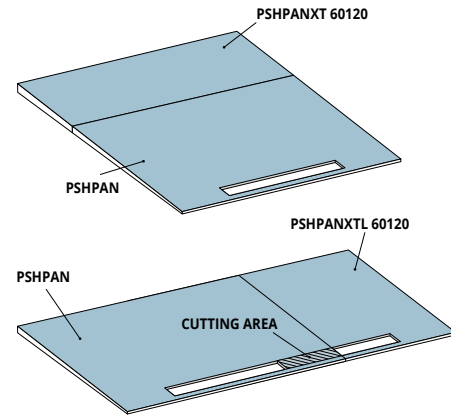

Article	Description	Pc/Pack.	€/Pc
PSHPAN	Proshower panel in moulded polystyrene 120x120 cm with glued Profoil	1	184,89

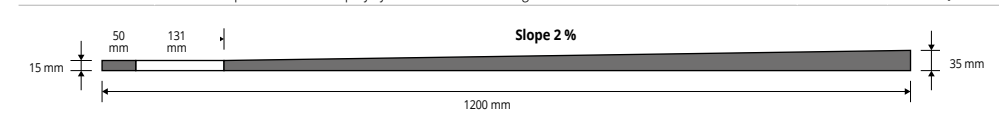

Article	Description	Pc/Pack.	€/Pc
PSHPANXT 60120	PROSHOWER PANEL EXTENSION 120x60 cm for PROSHOWER PANEL LINEAR - Slope 2%	1	92,44
PSHPANXTL 60120	LATERAL PROSHOWER PANEL EXTENSION 60x120 cm for PROSHOWER PANEL LINEAR - Slope 2%	1	92,44

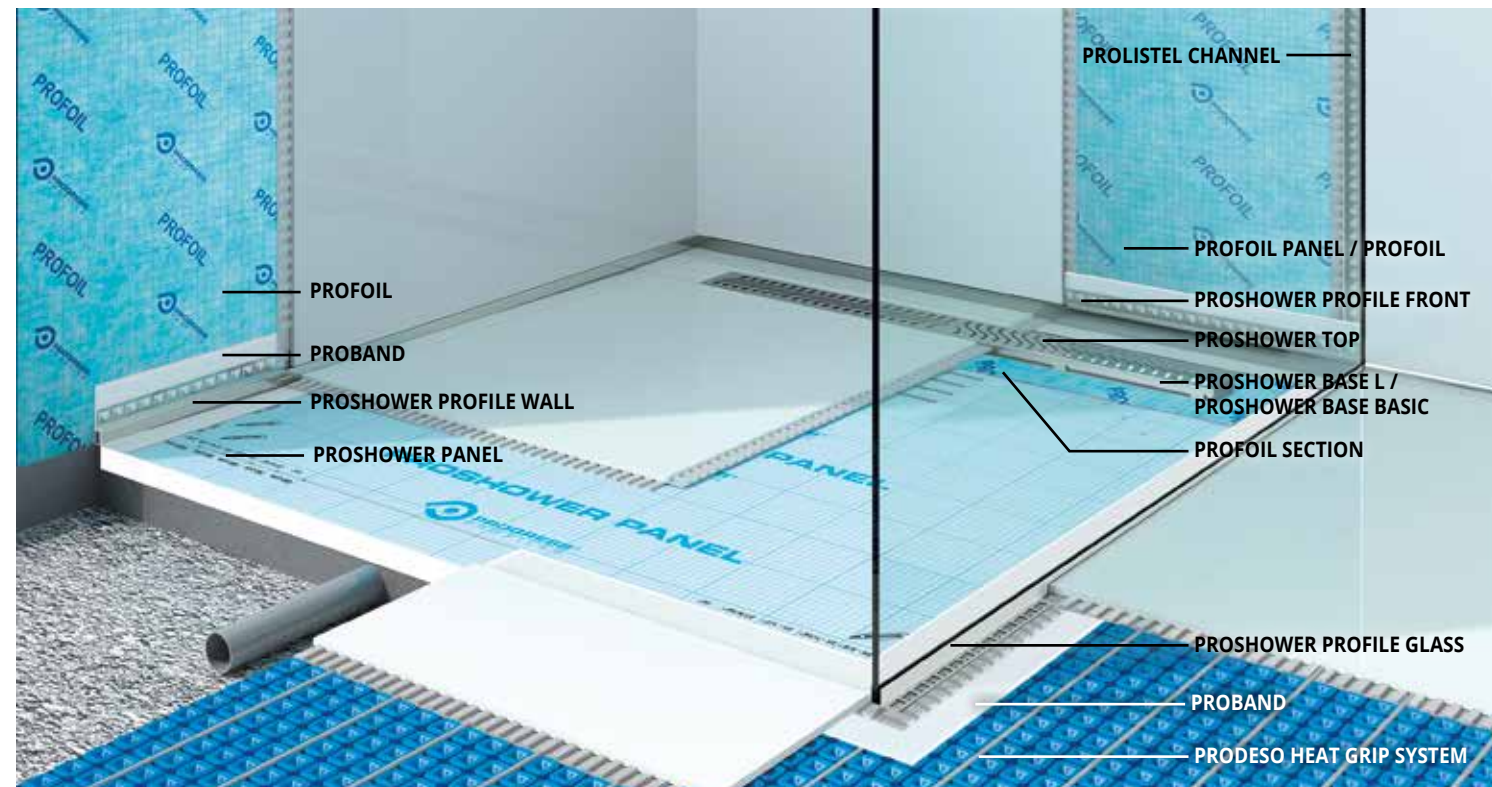

PROSHOWER BASE L is a channel body in stainless steel AISI 304/1.4301 - V2A steel for the realisation of floor-level shower. The body channel, with an overall height of 85 mm, is completed by 6 different grids in stainless steel. PROSHOWER BASE L undergoes electro-polishing and subsequent passivation, which guarantees excellent resistance in any environment. Its low thickness combined with the fully adjustable siphon, the modularity and the high number of grids make it a much sought-after solution.

PROSHOWER BASE L

SUPER POLISHED STAINLESS STEEL AISI 304/1.4301-V2A



* L 30 cm

DUCT BODY MADE OF AISI 304 STAINLESS STEEL

Article	Description	Pc/Pack.	€/Pc
PSHWDL 30	PROSHOWER BASE L-ACC-L 30 x 8 cm	1	262,65
PSHWDL 70	PROSHOWER BASE L-ACC-L 70 x 8 cm	1	334,75
PSHWDL 80	PROSHOWER BASE L-ACC-L 80 x 8 cm	1	355,35
PSHWDL 90	PROSHOWER BASE L-ACC-L 90 x 8 cm	1	375,95
PSHWDL 100	PROSHOWER BASE L-ACC-L 100 x 8 cm	1	396,55
PSHWDL 120	PROSHOWER BASE L-ACC-L 120 x 8 cm	1	448,05

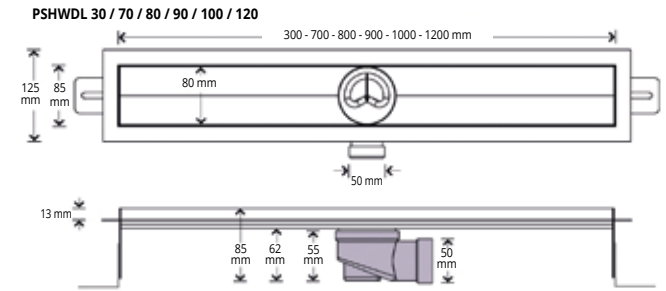

UPON REQUEST PROSHOWER BASE L with vertical siphon complete of installed Profoil membrane (code ref. PSHWDLVS...). Drain Ø 50 mm.

PROSHOWER BASE BASIC is a water collecting duct system in polypropylene for floor showers, available in several lengths and grids.

PROSHOWER BASE BASIC

GREY POLYPROPYLENE



GREY POLYPROPYLENE DUCT BODY

Article	Description	Pc/Pack.	€/Pc
PSHWBB 60	PROSHOWER BASE BASIC - 60 x 8 cm PP	1	154,50
PSHWBB 70	PROSHOWER BASE BASIC - 70 x 8 cm PP	1	164,80
PSHWBB 80	PROSHOWER BASE BASIC - 80 x 8 cm PP	1	175,10
PSHWBB 90	PROSHOWER BASE BASIC - 90 x 8 cm PP	1	185,40

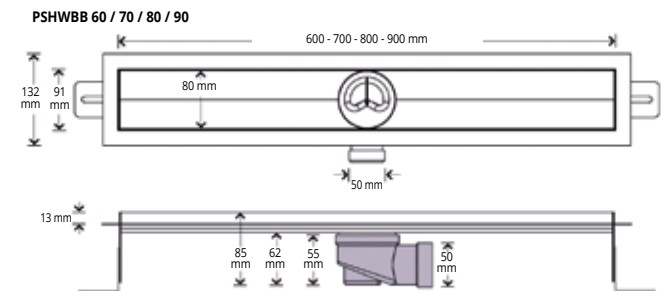

UPON REQUEST PROSHOWER BASE L with vertical siphon complete of installed Profoil membrane (code ref. PSHWBBVS...). Drain Ø 50 mm.

PROFOIL SECTION

HDPE E PP GUAINA

Article	Description	Pc/Pack.	€/Pc
PSHANT 30	PROFOIL section and double sided tape 3 lm	1	15,45
PSHANT 60	PROFOIL section and double sided tape 3 lm	1	17,51
PSHANT 70	PROFOIL section and double sided tape 3 lm	1	19,57
PSHANT 80	PROFOIL section and double sided tape 3 lm	1	23,69
PSHANT 90	PROFOIL section and double sided tape 3 lm	1	27,81
PSHANT 100	PROFOIL section and double sided tape 3 lm	1	31,93
PSHANT 120	PROFOIL section and double sided tape 3 lm	1	37,08



3 m PROFOIL SECTION AND DOUBLE SIDED TAPE

PROSHOWER TOP TILE - LINE - DESIGN - STRIPS - GRILL - SQUARE

SUPER POLISHED STAINLESS STEEL AISI 304/1.4301-V2A

TILE tileable

PSHWT 30/60/70/80/90/100/120

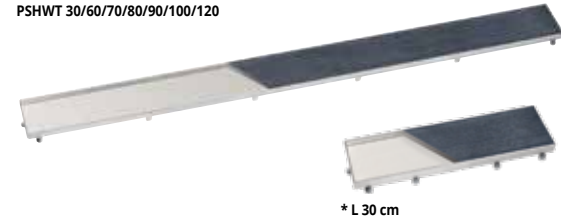

Article	Description	Pc/Pack.	€/Pc
PSHWT 30	PROSHOWER TILE - ACC - Grid L 30 x 8 cm made of AISI 304 stainless steel	1	108,15 *
PSHWT 60	PROSHOWER TILE - ACC - Grid L 60 x 8 cm made of AISI 304 stainless steel	1	123,60
PSHWT 70	PROSHOWER TILE - ACC - Grid L 70 x 8 cm made of AISI 304 stainless steel	1	128,75
PSHWT 80	PROSHOWER TILE - ACC - Grid L 80 x 8 cm made of AISI 304 stainless steel	1	133,90
PSHWT 90	PROSHOWER TILE - ACC - Grid L 90 x 8 cm made of AISI 304 stainless steel	1	139,05
PSHWT 100	PROSHOWER TILE - ACC - Grid L 100 x 8 cm made of AISI 304 stainless steel	1	154,50
PSHWT 120	PROSHOWER TILE - ACC - Grid L 120 x 8 cm made of AISI 304 stainless steel	1	169,95

Provided only combined with L. Proshower Base L.

LINE

PSHWL 60/70/80/90/100/120



Article	Description	Pc/Pack.	€/Pc
PSHWL 60	PROSHOWER LINE - ACC - Grid L 60 x 8 cm made of AISI 304 stainless steel	1	123,60
PSHWL 70	PROSHOWER LINE - ACC - Grid L 70 x 8 cm made of AISI 304 stainless steel	1	128,75
PSHWL 80	PROSHOWER LINE - ACC - Grid L 80 x 8 cm made of AISI 304 stainless steel	1	133,90
PSHWL 90	PROSHOWER LINE - ACC - Grid L 90 x 8 cm made of AISI 304 stainless steel	1	139,05
PSHWL 100	PROSHOWER LINE - ACC - Grid L 100 x 8 cm made of AISI 304 stainless steel	1	154,50
PSHWL 120	PROSHOWER LINE - ACC - Grid L 120 x 8 cm made of AISI 304 stainless steel	1	169,95

Provided only combined with L. Proshower Base L.

DESIGN

PSHWD 30/60/70/80/90/100/120

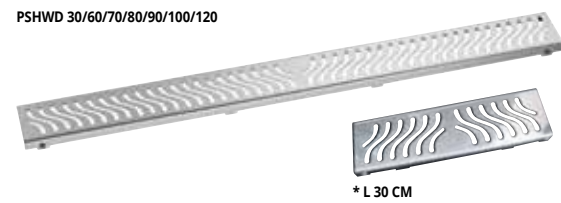

Article	Description	Pc/Pack.	€/Pc
PSHWD 30	PROSHOWER DESIGN - ACC - Grid L 30 x 8 cm made of AISI 304 stainless steel	1	108,15 *
PSHWD 60	PROSHOWER DESIGN - ACC - Grid L 60 x 8 cm made of AISI 304 stainless steel	1	123,60
PSHWD 70	PROSHOWER DESIGN - ACC - Grid L 70 x 8 cm made of AISI 304 stainless steel	1	128,75
PSHWD 80	PROSHOWER DESIGN - ACC - Grid L 80 x 8 cm made of AISI 304 stainless steel	1	133,90
PSHWD 90	PROSHOWER DESIGN - ACC - Grid L 90 x 8 cm made of AISI 304 stainless steel	1	139,05
PSHWD 100	PROSHOWER DESIGN - ACC - Grid L 100 x 8 cm made of AISI 304 stainless steel	1	154,50
PSHWD 120	PROSHOWER DESIGN - ACC - Grid L 120 x 8 cm made of AISI 304 stainless steel	1	169,95

STRIPS

PSHWST 60/70/80/90/100/120



Article	Description	Pc/Pack.	€/Pc
PSHWST 60	PROSHOWER STRIPS - ACC - Grid L 60 x 8 cm made of AISI 304 stainless steel	1	123,60 *
PSHWST 70	PROSHOWER STRIPS - ACC - Grid L 70 x 8 cm made of AISI 304 stainless steel	1	128,75 *
PSHWST 80	PROSHOWER STRIPS - ACC - Grid L 80 x 8 cm made of AISI 304 stainless steel	1	133,90 *
PSHWST 90	PROSHOWER STRIPS - ACC - Grid L 90 x 8 cm made of AISI 304 stainless steel	1	139,05 *
PSHWST 100	PROSHOWER STRIPS - ACC - Grid L 100 x 8 cm made of AISI 304 stainless steel	1	154,50 *
PSHWST 120	PROSHOWER STRIPS - ACC - Grid L 120 x 8 cm made of AISI 304 stainless steel	1	169,95 *

GRILL

PSHWGR 60/70/80/90/100/120



Article	Description	Pc/Pack.	€/Pc
PSHWGR 60	PROSHOWER GRILL - ACC - Grid L 60 x 8 cm made of AISI 304 stainless steel	1	123,60 *
PSHWGR 70	PROSHOWER GRILL - ACC - Grid L 70 x 8 cm made of AISI 304 stainless steel	1	128,75 *
PSHWGR 80	PROSHOWER GRILL - ACC - Grid L 80 x 8 cm made of AISI 304 stainless steel	1	133,90 *
PSHWGR 90	PROSHOWER GRILL - ACC - Grid L 90 x 8 cm made of AISI 304 stainless steel	1	139,05 *
PSHWGR 100	PROSHOWER GRILL - ACC - Grid L 100 x 8 cm made of AISI 304 stainless steel	1	154,50 *
PSHWGR 120	PROSHOWER GRILL - ACC - Grid L 120 x 8 cm made of AISI 304 stainless steel	1	169,95 *

SQUARE

PSHWSQ 60/70/80/90/100/120



Article	Description	Pc/Pack.	€/Pc
PSHWSQ 60	PROSHOWER SQUARE - ACC - Grid L 60 x 8 cm made of AISI 304 stainless steel	1	123,60 *
PSHWSQ 70	PROSHOWER SQUARE - ACC - Grid L 70 x 8 cm made of AISI 304 stainless steel	1	128,75 *
PSHWSQ 80	PROSHOWER SQUARE - ACC - Grid L 80 x 8 cm made of AISI 304 stainless steel	1	133,90 *
PSHWSQ 90	PROSHOWER SQUARE - ACC - Grid L 90 x 8 cm made of AISI 304 stainless steel	1	139,05 *
PSHWSQ 100	PROSHOWER SQUARE - ACC - Grid L 100 x 8 cm made of AISI 304 stainless steel	1	154,50 *
PSHWSQ 120	PROSHOWER SQUARE - ACC - Grid L 120 x 8 cm made of AISI 304 stainless steel	1	169,95 *

* = Production on demand with minimum quantity of 10 pcs. Delivery time 4/5 weeks, price to agree

Prices are referred to whole packs.

DRAIN REDUCTION

POLYPROPYLENE

Article	Description	Pc/Pack.	€/Pc
PSHWRD 5040	50 to 40 mm polypropylene drain reduction	1	10,30

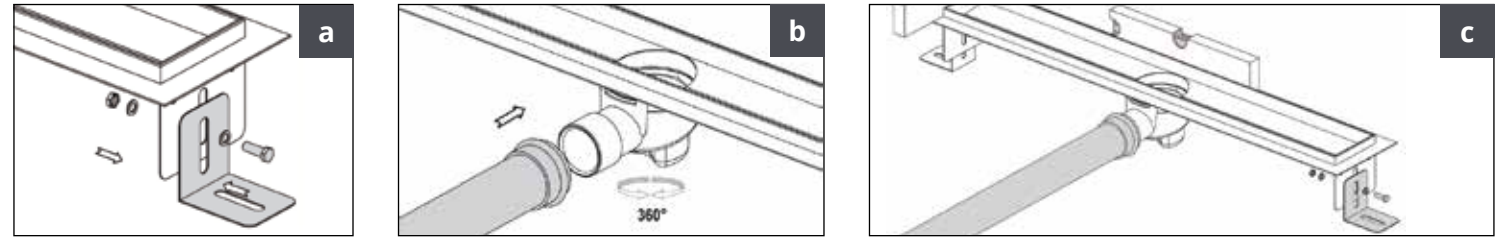

MODULAR ASSEMBLY KIT

Article	Description	Pc/Pack.	€/Pc
PSHWRD	Modular assembly kit to make drain ducts of any length	1	26,78

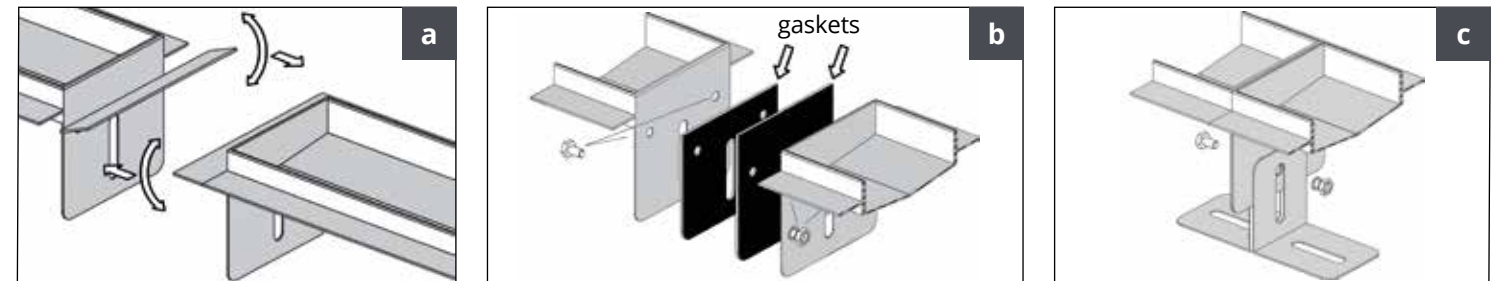

© 2019 All rights reserved by Progress Profiles. Printed in Italy

© 2019 All rights reserved by Progress Profiles. Printed in Italy

PROSHOWER PROFILE GLASS

SATINED STAINLESS STEEL AISI 304 / 1.4301 - V2A

PROSHOWER PROFILE GLASS Suitable profile for fixing glass slabs in case of floor level showers with a slope of 2%. Due to its particular shape and finish in satin-finish stainless steel AISI 304 / 1.4301 - V2A, it covers and decorates the visible side of the screed.

PROSHOWER PROFILES GLASS IN SATINED STAINLESS STEEL AISI 304/1.4301-V2A - degreased and passivated thermo packed

Article	Description	Pc/Pack.	€/Pc
PSHWPGACS 100DX	Proshower profile glass satined stainless steel rx L 100 cm	1	93,68
PSHWPGACS 100SX	Proshower profile glass satined stainless steel lt L 100 cm	1	93,68
PSHWPGACS 150DX	Proshower profile glass satined stainless steel rx L 150 cm	1	130,76
PSHWPGACS 150SX	Proshower profile glass satined stainless steel lt L 150 cm	1	130,76
PSHWPGACS 200DX	Proshower profile glass satined stainless steel rx L 200 cm	1	169,90
PSHWPGACS 200SX	Proshower profile glass satined stainless steel lt L 200 cm	1	169,90



EXAMPLES AND INSTRUCTIONS FOR LAYING METHODS

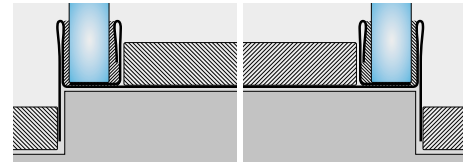

1. Choose "PROSHOWER PROFILE GLASS" according to the desired length. 2. Cut "PROSHOWER PROFILE GLASS" to the desired length and apply the adhesive on the support where the profile will be laid. 3. Press the anchoring flange of "PROJOLLY SQUARE" into the adhesive. 4. Lay the tiles, aligning them with the profile leaving a 2 mm joint. Remove immediately all remains of adhesive from the surface of the profile. 5. Fill the joints between the profile and the tiles with grout, in order to avoid water stagnation. Remove immediately all the remains of grout from the surface of the profile. 6. Insert the sheet of glass and seal

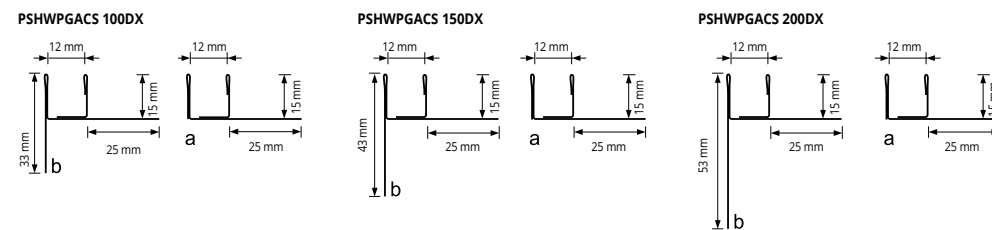
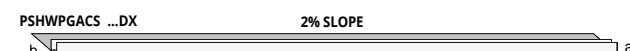
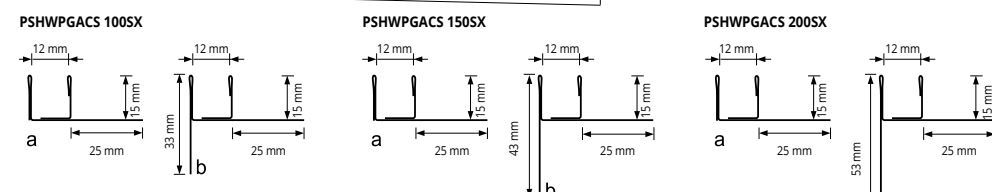
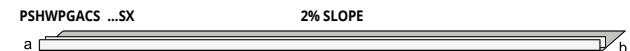

PROLISTEL CHANNEL

ANODIZED AND POLISHED ALUMINIUM

PROLISTEL CHANNEL is a F-shaped strip in anodized and polished aluminum suitable to decorate the wall coverings in ceramic tiles and natural stones. Its section allows the realization of a decorative joint which can also be used as a guide for the fixing of sheets of glass on floors and walls. Its particular section and the availability in two different finishes make **PROLISTEL CHANNEL** a much sought-after profile that allows an easy workmanlike application.

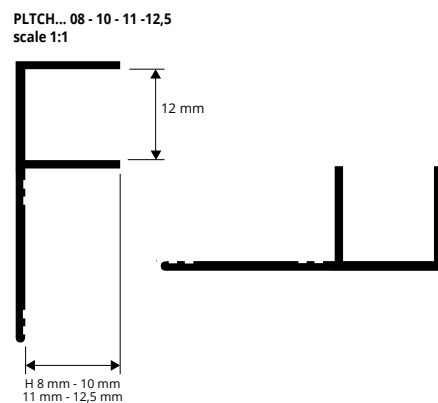

COLOURS

ANODIZED	POLISHED
AA - Anodized silver alum.	BC - Polished chrome alum.

ANODIZED SILVER ALUMINIUM
bar length 2,7 lm - pack. 40 Pcs - 108 lm

Article	H mm	€/lm	€/Pc
PLTCHAA 08	8	11,85	32,00
PLTCHAA 10	10	12,88	34,78
PLTCHAA 11	11	13,65	36,86
PLTCHAA 125	12,5	14,42	38,93

POLISHED CHROME ALUMINIUM
bar length 2,7 lm - pack. 40 Pcs - 108 lm

Article	H mm	€/lm	€/Pc
PLTCHBC 08	8	13,91	37,56
PLTCHBC 10	10	14,94	40,34
PLTCHBC 11	11	15,71	42,42
PLTCHBC 125	12,5	16,48	44,50

EXAMPLES AND INSTRUCTIONS FOR LAYING METHODS

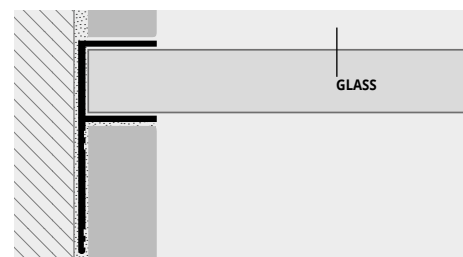

1. Choose "PROLISTEL CHANNEL" according to the visible surface and desired finish. 2. Cut "PROLISTEL CHANNEL" to the desired length and apply the adhesive on the surface where the profile will be laid. 3. Press "PROLISTEL CHANNEL" into the adhesive, aligning it with the tiles leaving a 2 mm. joint. Remove immediately all remains of adhesive from the surface of the profile. 4. Fill the joint between the profile and tiles with grout in order to avoid water stagnation. Remove immediately all the remains of grout from the surface of the profile.

PROSHOWER PROFILE WALL Profile in satin-finish stainless steel AISI 304 / 1.4301 - V2A. It is suitable to cover and decorate the visible part of wall beside the shower tray in case of floor level showers with a slope of 2%.

PROSHOWER PROFILE WALL

SATINED STAINLESS STEEL AISI 304 / 1.4301 - V2A

PROSHOWER PROFILES WALL IN SATINED STAINLESS STEEL AISI 304/1.4301-V2A - degreased and passivated thermo packed

Article	Description	Pc/Pack.	€/Pc
PSHWPLACS 1010DX	Proshower profile wall satined stainless steel 10 mm rx L 100 cm	1	47,33
PSHWPLACS 1010SX	Proshower profile wall satined stainless steel 10 mm lt L 100 cm	1	47,33
PSHWPLACS 1015DX	Proshower profile wall satined stainless steel 10 mm rx L 150 cm	1	61,75
PSHWPLACS 1015SX	Proshower profile wall satined stainless steel 10 mm lt L 150 cm	1	61,75
PSHWPLACS 1020DX	Proshower profile wall satined stainless steel 10 mm rx L 200 cm	1	77,20
PSHWPLACS 1020SX	Proshower profile wall satined stainless steel 10 mm lt L 200 cm	1	77,20
PSHWPLACS 12510DX	Proshower profile wall satined stainless steel 12,5 mm rx L 100 cm	1	47,84
PSHWPLACS 12510SX	Proshower profile wall satined stainless steel 12,5 mm lt L 100 cm	1	47,84
PSHWPLACS 12515DX	Proshower profile wall satined stainless steel 12,5 mm rx L 150 cm	1	62,26
PSHWPLACS 12515SX	Proshower profile wall satined stainless steel 12,5 mm lt L 150 cm	1	62,26
PSHWPLACS 12520DX	Proshower profile wall satined stainless steel 12,5 mm rx L 200 cm	1	78,23
PSHWPLACS 12520SX	Proshower profile wall satined stainless steel 12,5 mm lt L 200 cm	1	78,23



EXAMPLES AND INSTRUCTIONS FOR LAYING METHODS

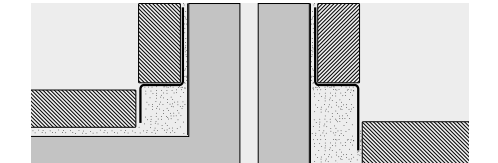

1. Choose "PROSHOWER PROFILE WALL" according to the desired length. 2. Cut "PROSHOWER PROFILE WALL" to the desired length and apply the adhesive on the support where the profile will be laid. 3. Press the anchoring flange of "PROJOLLY SQUARE" into the adhesive. 4. Lay the tiles, aligning them with the profile leaving a 2 mm joint. Remove immediately all remains of adhesive from the surface of the profile. 5. Fill the joints between the profile and the tiles with grout, in order to avoid water stagnation. Remove immediately all the remains of grout from the surface of the profile. 6. Insert the sheet of glass and seal

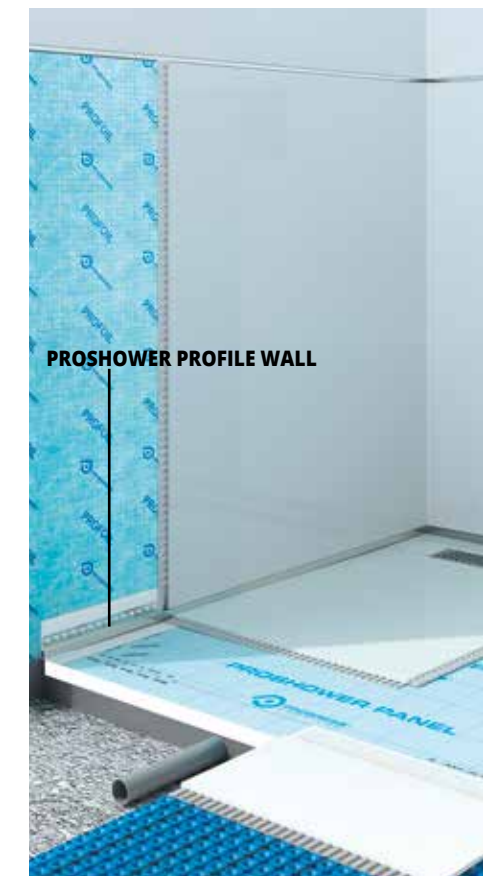
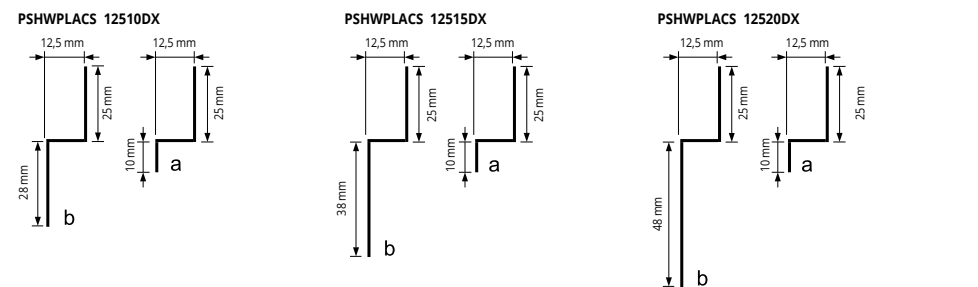
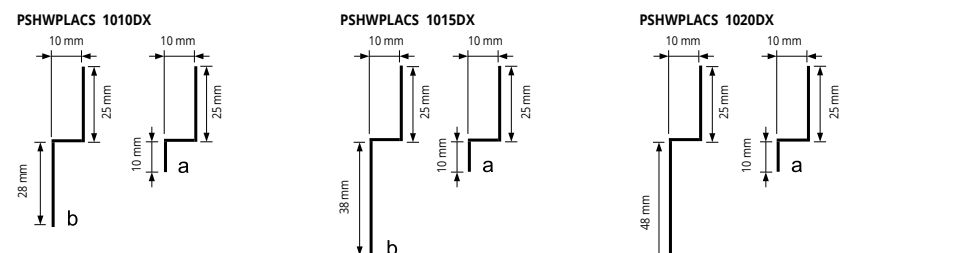
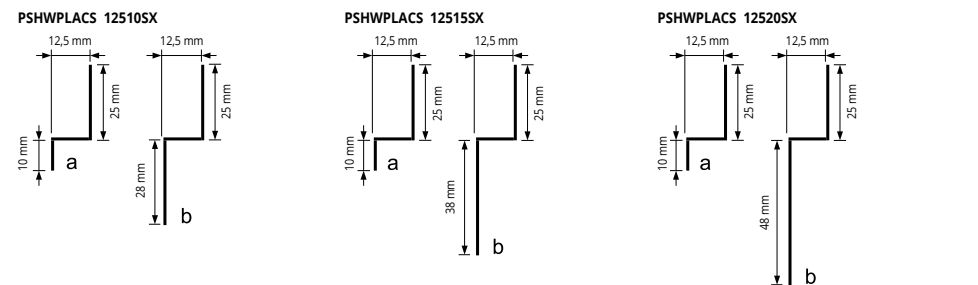
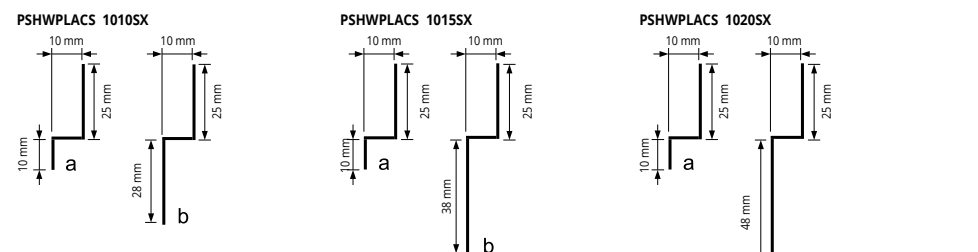

PROSHOWER PROFILE WALL

PROFOIL

ROLLS IN HDPE AND PP

PROFOIL is a waterproofing polyethylene membrane with nonwoven polypropylene fabric on both side that guarantees high adhesion to the support.

ROLLS IN HDPE AND PP - Thickness 0,42 mm

Article	Width roll H x L m	total m ²	€/m ²	€/Roll
PFLO 0430	1 x 30	30	11,48	344,40
PFLO 0405	1 x 5	5	15,97	79,85

AREAS OF USE

• **Use.** Waterproofing of substrates and vertical structures before the laying of ceramic and stone materials in areas subject to occasional contact with water like bathrooms and kitchens, with high vapor pressure like saunas and Turkish baths and with permanent contact with water also in pressure like swimming pools and tanks. On screed without cracks and completely cured, old ceramic floors and natural stones anchored to the substrate, concrete completely cured and wood supports.

• **Don't use.** On bituminous coverings, over insulating panels and lightweight screed.

WARNINGS

Store in a cool and dry place avoiding direct sunlight and sources of heat. Read the data sheet before applying; in case of special applications please call the technical department.



PROFOIL PASTE

WATERPROOFING ELASTIC MEMBRANE

PROFOIL PASTE is a ready to use thin-layer waterproofing elastic membrane with low emissions of volatile organic compounds.

WATERPROOFING ELASTIC MEMBRANE

Article	Kg./Bucket	Bucket/ Pallet	€/Kg.	€/Bucket	€/Pallet
PFLOPST 04	4	64	10,04	40,16	2.570,24
PFLOPST 10	10	36	9,53	95,30	3.430,80

AREAS OF USE AND WARNINGS, see page 174



PROBAND 150/250

ROLLS IN HDPE AND PP



ROLLS IN HDPE AND PP - Thickness 0,42 mm

Article	Roll width H mm x L m	Rolls/ Pack.	€/lm	€/Roll	€/Pack.
PRBPE 1505	150 x 5	20	3,40	17,00	340,00
PRBPE 1507	150 x 7,5	16	3,40	25,50	408,00
PRBPE 1530	150 x 30	6	2,63	78,90	473,40
PRBPE 2505	250 x 5	10	5,59	27,95	279,50
PRBPE 2530	250 x 30	3	4,84	145,20	435,60

AREAS OF USE AND WARNINGS, see page 171

PRBPE 1505 available while stocks last

CORNERS and PIPE COLLAR

HDPE E PP



PREFORMED CORNERS AND PIPE COLLAR IN HDPE AND PP
Thickness 0,42 mm

Article	H x L mm	Rolls/Pack.	€/Pc	€/Pack.
PRBI (internal)	150 x 150	10 Pcs	7,98	79,80
PRBE (external)	150 x 150	10 Pcs	7,98	79,80
PRBT (pipe collar)	125 x 125	10 Pcs	7,73	77,30

AREAS OF USE AND WARNINGS, see page 172

PROBAND FIX

MOISTURE-CURE SEALANT



MOISTURE-CURE SEALANT
pack. of 12 cartridges

Article	Colours	Cartridge ml	€/Pc	€/Pack.
PRBFXB	WHITE	290	13,91	166,92
PRBFXG	GREY	290	13,91	166,92



GUN FOR MOISTURE-CURE SEALANT CARTRIDGE

Article	Pc/Pack	€/Pc
PRBFXGUN	1	278,10



MOISTURE-CURE SEALANT CARTRIDGE
pack. of 12 cartridges

Article	Colours	Cartridge ml	€/Pc	€/Pack.
PRBFXUB	WHITE	600	27,30	327,60
PRBFXUG	GREY	600	27,30	327,60

AREAS OF USE AND WARNINGS, see page 172

PROFOIL PANEL are high density extruded polystyrene panels covered on both sides with a steam- and waterproofing membrane. The membrane is waterproofing and the adhesive to fix them reinforces the panels for a quick and inexpensive laying.

PROFOIL PANEL

HIGH DENSITY EXTRUDED POLYSTYRENE PANEL

PROFOIL PANEL 1524 mm - high density extruded polystyrene
915 mm x 1524 mm = 1,394 m²

Article	H mm	Pcs /pallet	Mq /pallet	€/Mq	€/Pc	€/Pallet
PFLPAN6	6,35	85	118,49	34,51	48,11	4089,35
PFLPAN9	9,50	80	111,52	36,62	51,05	4084,00
PFLPAN13	12,70	60	83,64	37,85	52,76	3165,60
PFLPAN16	15,90	50	69,70	40,74	56,79	2839,50
PFLPAN25	25,00	30	41,82	41,66	58,07	1742,10
PFLPAN38	38,10	20	27,88	50,21	69,99	1399,80
PFLPAN50	50,80	15	20,91	57,63	80,34	1205,10

THICKNESS PROFOIL PANEL

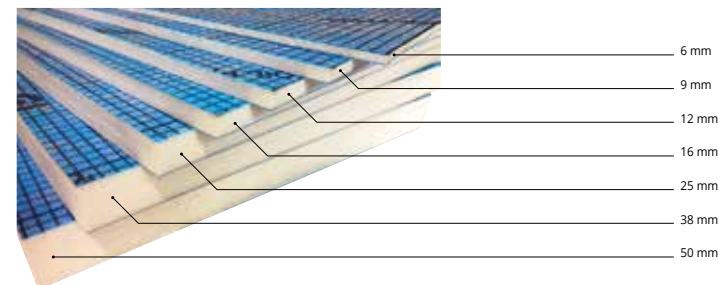

PROFOIL PANEL 2700 mm - high density extruded polystyrene
915 mm x 2700 mm = 2,470 m²

Article	H mm	Pcs /pallet	Mq /pallet	€/Mq	€/Pc	€/Pallet
PFLPAN627	6,35	85	209,95	34,51	85,24	7.245,40
PFLPAN927	9,50	80	197,60	36,62	90,45	7.236,00
PFLPAN1327	12,70	60	148,20	37,85	93,49	5.609,40
PFLPAN1627	15,90	50	123,50	40,74	100,63	5.031,50
PFLPAN2527	25,00	30	74,10	41,66	102,90	3.087,00
PFLPAN3827	38,10	20	49,40	50,21	124,02	2.480,40
PFLPAN5027	50,80	15	37,05	57,63	142,35	2.135,25

PROFOIL PANEL in 2700 mm is available only in small quantity. Please contact the office for availability.

PFLPAN...

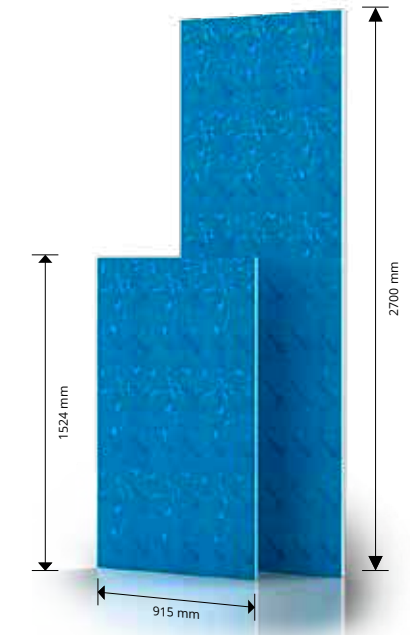

PROFOIL AND PROBAND DOWELS, WASHERS, SCREWS

STAINLESS STEEL/ZINC-COATED METAL/GLASS FIBER NET



PROFOIL DOWELS - pack. 250 Pc

Article	L mm	€/Pc	€/Pack.
TZPFP 110 (zinc-coated metal)	100	1,34	335,00
TZPFP 140 (zinc-coated metal)	140	1,49	372,50
TZPFP 170 (zinc-coated metal)	170	1,65	412,50
TZPFP 200 (zinc-coated metal)	200	1,80	450,00
TIPFP 110 (stainless steel)	110	2,58	645,00
TIPFP 140 (stainless steel)	140	2,78	695,00
TIPFP 170 (stainless steel)	170	2,99	747,50
TIPFP 200 (stainless steel)	200	3,19	797,50
TIPFP 250 (stainless steel)	250	3,71	927,50



PROFOIL WASHERS (ZINC-COATED METAL) - pack. 100 Pc

Article	Pcs/Pack.	ø mm	€/Pc	€/Pack.
RFPFP 36	100	35	0,26	26,00

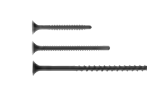

PROFOIL SCREWS (ZINC-COATED METAL)

Article	Pcs/Pack.	L mm	€/Pc	€/Pack.
VACPFP 35	1000	35	0,033	33,00
VACPFP 55	1000	45	0,037	37,00
VACPFP 80	1000	80	0,077	77,00



PROBAND NET - roll 50 m

Article	H mm	€/Pc
PRBNET 100	100	8,76

PROFOIL PANEL NICHE

HIGH DENSITY EXTRUDED POLYSTYRENE

PROFOIL PANEL NICHE are prefabricated built-in elements of PROFOIL PANEL to make indoor wall niches and support surfaces. The niches can be linked to the waterproofing systems PROFOIL and PROFOIL PANEL. The fixing of the shelf inside the niche is optional. The shelf, part of the, can be fixed at the needed height. It is available in 4 sizes.

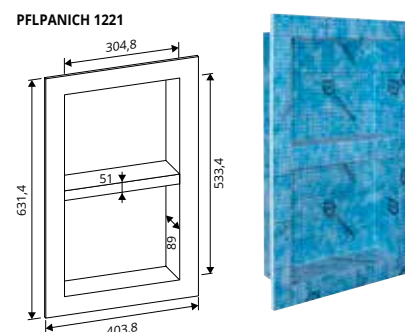
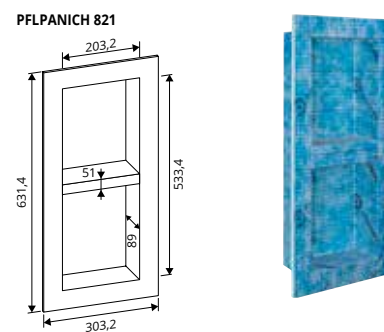
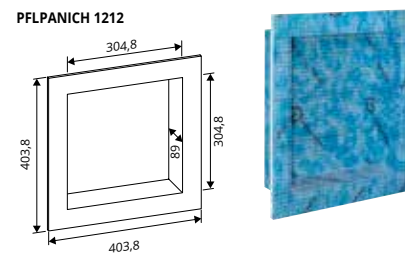
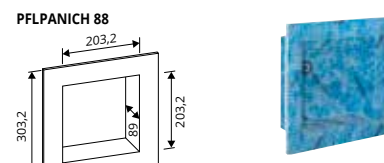

Article	Description	Pcs/Pack.	€/Pc
PFLPANICH 88	WATERPROOFING NICHE MADE OF PROFOIL PANEL of 12,5mm - 1/2", Inside size of the niche 203,2 x 203,2 mm - 8" x 8"	1	54,95 *

Article	Description	Pcs/Pack.	€/Pc
PFLPANICH 1212	WATERPROOFING NICHE MADE OF PROFOIL PANEL of 12,5mm - 1/2", Inside size of the niche 304,8 x 304,8 mm - 12" x 12"	1	63,90 *

Article	Description	Pcs/Pack.	€/Pc
PFLPANICH 821	WATERPROOFING NICHE MADE OF PROFOIL PANEL of 12,5mm - 1/2", Inside size of the niche 203,2 x 533,4 mm - 8" x 21"	1	84,50 *

Article	Description	Pcs/Pack.	€/Pc
PFLPANICH 1221	WATERPROOFING NICHE MADE OF PROFOIL PANEL of 12,5mm - 1/2", Inside size of the niche 304,8 x 533,4 mm 12" x 21"	1	94,90 *

© 2019 All rights reserved by Progress Profiles. Printed in Italy

© 2019 All rights reserved by Progress Profiles. Printed in Italy

PROGOBOARD PANEL

HIGH DENSITY POLYISOCYANURATE FOAM PANEL

PROGOBOARD PANEL highdensity polyisocyanurate foam panel, covered on both sides with a fibre-glass reinforced cement-based waterproof coating to allow the laying of tiles. The panels, tested for a resistance long duration, are available in thickness of 6,25 / 12,5 / 25 and 50 mm, size of 92 x 152 cm and 122 x 244 cm and can be used on floors, false ceilings, walls, showers and ceilings.



PROGOBOARD PANEL - highdensity polyisocyanurate foam

Article	Description	Pcs/pallet	Mq/pallet	€/Pc	€/Pallet
PGOBOR06	PRO-GOBOARD H 6,25 mm - 92 cm x 152 cm - 1,40 m ²	75	105	65,00	4.875,00
PGOBOR125	PRO-GOBOARD H 12,5 mm - 92 cm x 152 cm - 1,40 m ²	60	84	73,00	4.380,00
PGOBOR25	PRO-GOBOARD H 25 mm - 122 cm x 244 cm - 2,98 m ²	30	89,4	399,02	11.970,60
PGOBOR50	PRO-GOBOARD H 50 mm - 122 cm x 244 cm - 2,98 m ²	15	44,70	689,08	10.336,20



☞ = News 2019

* = Production on demand with minimum quantity of 5 pcs. Delivery time 4/5 weeks, price to agree

Prices are referred to whole packs.



SHOWER SYSTEMS